

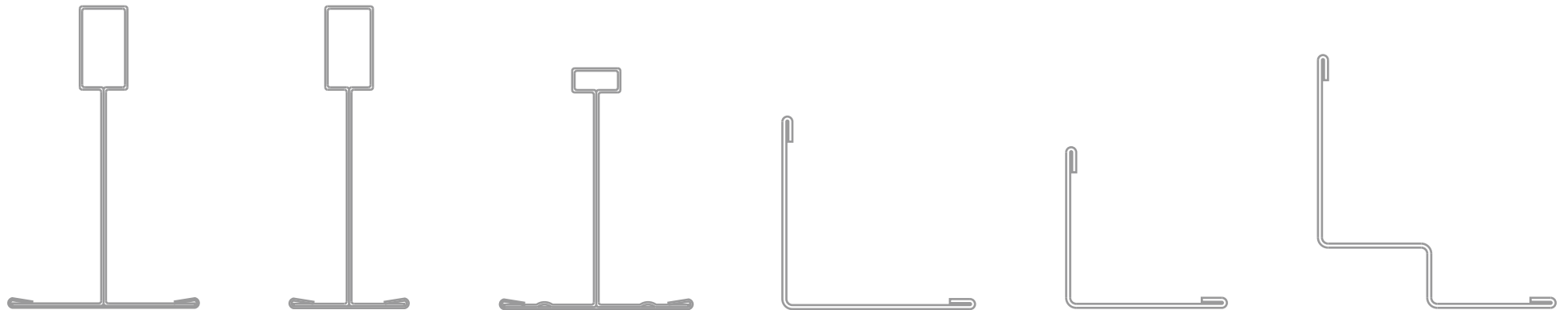

evolution of classic

International Metallic Systems





International Metallic Systems



ΕΛ Η εταιρεία SCP διευρύνοντας την γκάμα των προϊόντων της και αξιοποιώντας την τεχνογνωσία της, προχώρησε στον σχεδιασμό και την παραγωγή νέου εμφανούς συστήματος σκελετού στήριξης ψευδοροφής “T” πλάτους 24mm.

Οι κύριοι οδηγοί ύψους 38mm και οι εγκάρσιοι ύψους 30mm, με σύστημα σύνδεσης Lock χαρακτηρίζονται από διατομές συναρμογής που ασφαλίζουν την οροφή χωρίς την χρήση εργαλείων αποτρέποντας συγχρόνως την στρέψη.

Ο σκελετος στήριξης IMS Lock παράγεται σύμφωνα με τις οδηγίες ποιοτικού ελέγχου ISO 9001: 2000, και εναρμονίζεται με τις προδιαγραφές του ευρωπαϊκού προτύπου EN 13964 /2014.

Eng IMS T suspension, by SCP, certified by ISO 9001 : 2000, is produced according to european EN 13964 standards.

Main runners 38mm height and Cross Tees, 30mm height the IMS elements are produced in 24mm width, joined with Lock system, which allows easy and fast installation and prevents torsion ,securing at the same time secures the ceiling construction.

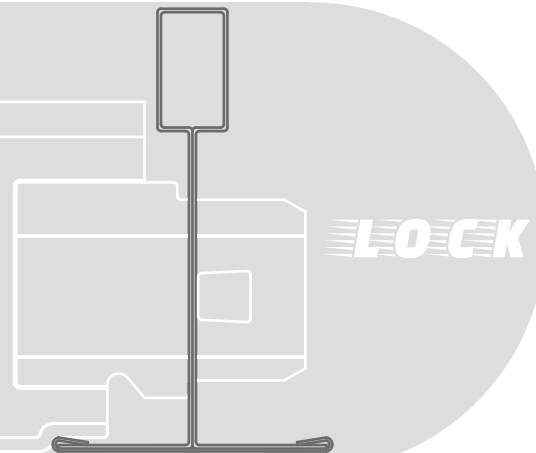

Χρωματικές επιλογές / Colour Options



Pure White
Ral 9010



White Aluminium
Ral 9006



Gloss Black
Ral 9005



Quartz Grey
Ral 7039



Mirror

Δεματοποίηση / Packing details

T ₂₄	Code	Description	Pcs	Lm	Kg/p
	60150	main runner	25	93,75	28,4
	64150	cross tee 1,20	75	90	24,8
	62150	cross tee 0,60	100	60	16,5

Reaction to fire



Corrosion resistance



Environment



Κύριος οδηγός / Main runner

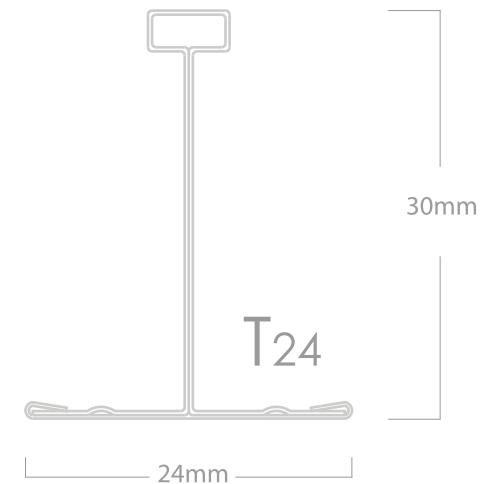
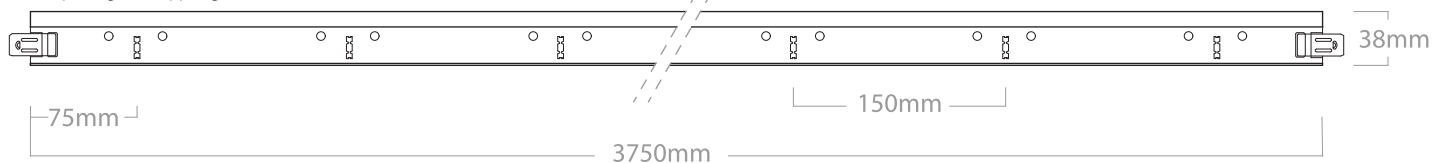

Δευτερέων οδηγός 1,20 / Cross tee 1,20

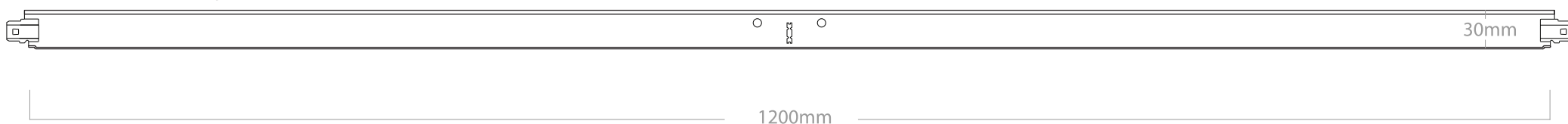

Δευτερέων οδηγός 0,60 / Cross tee 0,60



Συμβατότητα με τύπους οροφής / Tile type compatibility

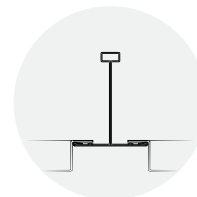

Semi-concealed

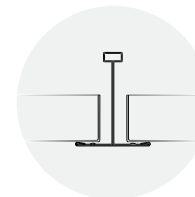

Exposed

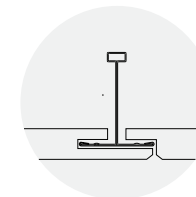

Concealed

hook

ΕΛ Ο σκελετός στήριξης IMS "T", της εταιρείας SCP, σχεδιάστηκε και παράγεται σύμφωνα με τις οδηγίες ποιοτικού ελέγχου ISO 9001 : 2000, κατατάσσεται σε REI180 σύμφωνα με το τεστ πυρασφάλειας του Ινστιτούτου Giordano και εναρμονίζεται με τις προδιαγραφές του ευρωπαϊκού προτύπου EN 13964/2014.

Οι κύριοι και οι εγκάρσιοι οδηγοί ύψους 38mm, και πλάτους 24 ή 15mm, με σύστημα σύνδεσης Hook τοποθετούνται εύκολα, γρήγορα και αποτρέπουν τη στρέψη. Μπορούν να αποσυναρμολογηθούν και να συναρμολογηθούν αρκετές φορές, χωρίς να καταστρέφονται και χωρίς την χρήση εργαλείων.

Eng IMS T suspension, by SCP, certified by ISO 9001 : 2000 , rated, for fire resistance, REI180, is produced according to european EN 13964 standards.

Main runners and secondary elements , all 38mm height and 25 or 15mm width, are joined with Hook system, which allows easy and fast installation and prevents torsion. They can be installed and removed many times, without being damaged, even without use of tools.

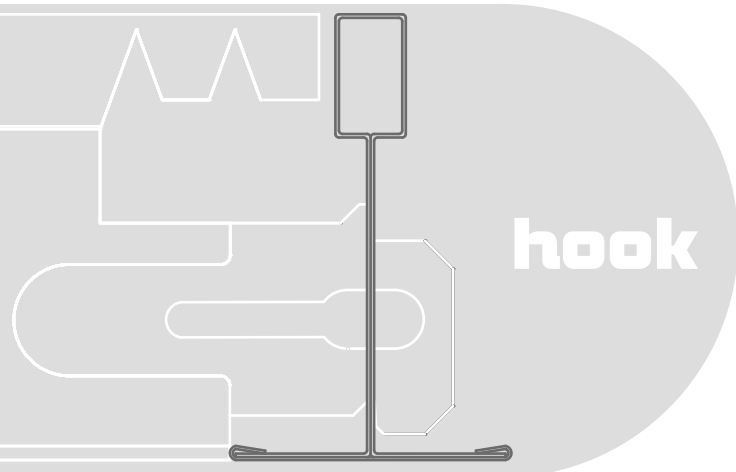

Χρωματικές επιλογές / Colour Options



Pure White
Ral 9010



White Aluminium
Ral 9006



Gloss Black
Ral 9005



Quartz Grey
Ral 7039



Mirror

Δεματοποίηση / Packing details

T24

Code	Description	Pcs	Lm	Kg/P
80150	main runner	25	93,75	28,4
84150	cross tee 1,20	50	60	18,2
82150	cross tee 0,90	75	45	13,7

T15

Code	Description	Pcs	Lm	Kg
90150	main runner	30	112,5	27,5
94150	cross tee 1,20	80	96	23,5
92150	cross tee 0,90	120	72	17,6

Reaction to fire



Corrosion resistance



Environment



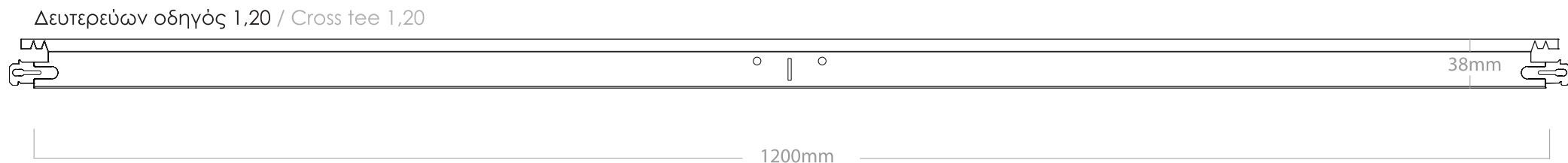
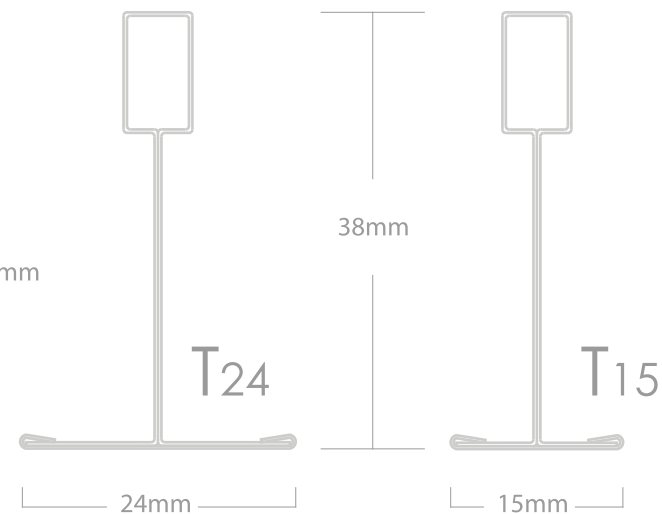
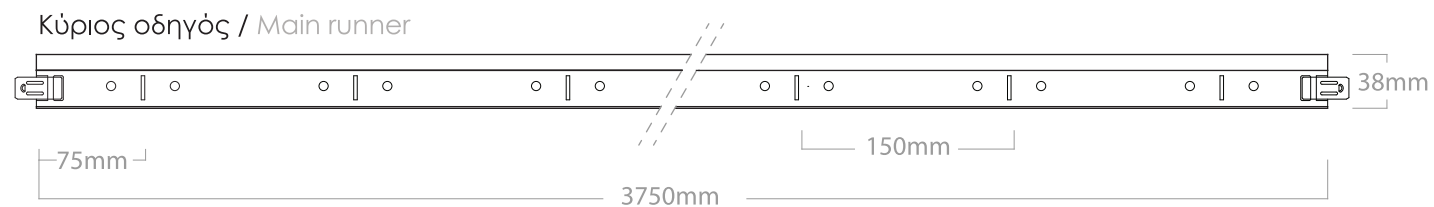

Συμβατότητα με τύπους οροφής / Tile type compatibility

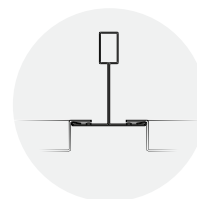

Semi-concealed

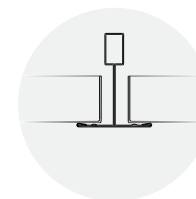

Exposed

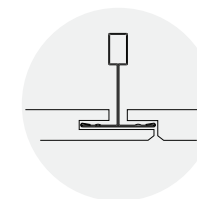

Concealed

Wall angles

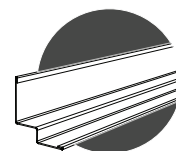
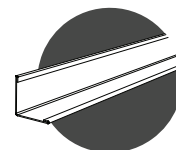
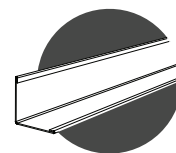
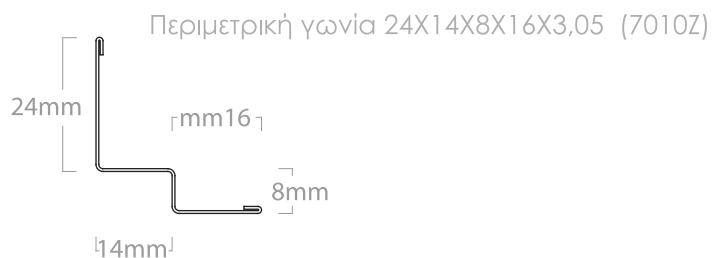
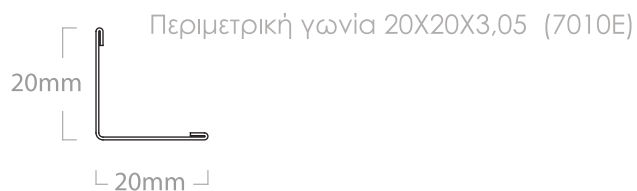
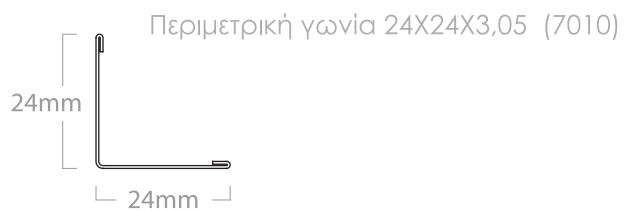

Δεματοποίηση / Packing details

Code	Description	Pcs	Lm	Kg/p
7010	Wall angle trim 24x24	40	122	24
7010E1	Wall angle trim 20x20	50	152,5	26
7010Z1	Wall angle trim Z	30	91,5	25

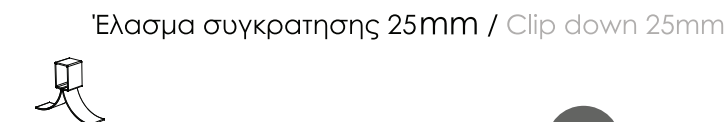
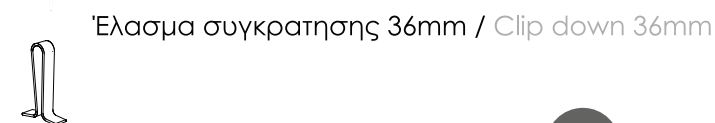
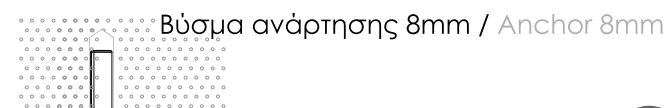
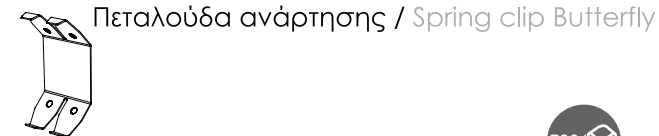

Χρωματικές επιλογές / Colour Options



Pure White
Ral 9010



White Aluminium
Ral 9006



Mirror



Gloss Black
Ral 9005



Quartz Grey
Ral 7039

ISO

9001 / 2000



REI 180

Giordano Institute / Italy



CE

EN 13964





Stampa Ceiling Products

Show room : 163 IERA ODOS STR. 12241

TEL. 2103412231 FAX. 2103454149

WEBSITE : scp-production.gr

E-MAIL: tech@scp-production.gr